

















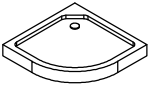

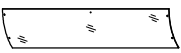
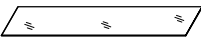

A		8	J		2	S		4
B	 ST4X40	8	K	 ST4X12	8	T	 ST4X8	4
C		8	L		4	U		1
D	 ST4X30	8	M	 ST4X10	4			
E		2	N		2			
F		2	O		2			
G		4	P		2			
H		2	Q		2			
I		4	R		2			

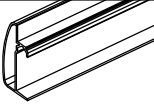

Ø6,Ø2.8



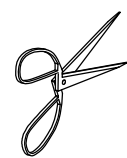
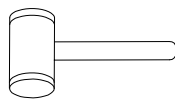
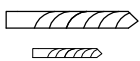
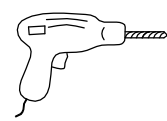
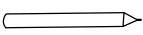
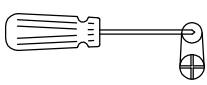
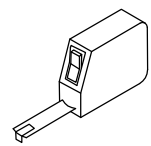
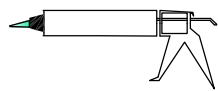
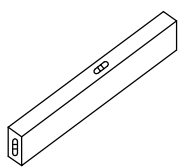
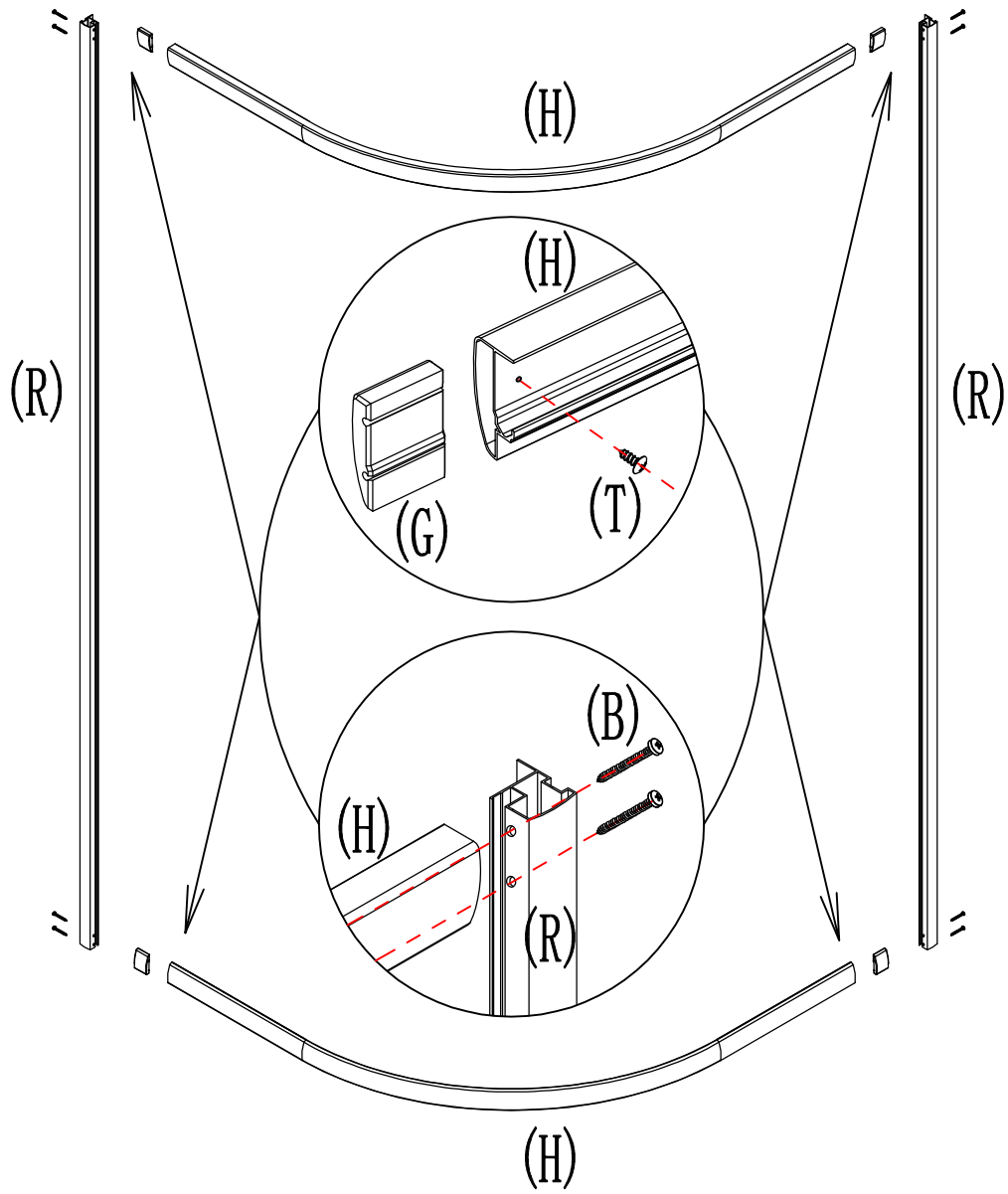
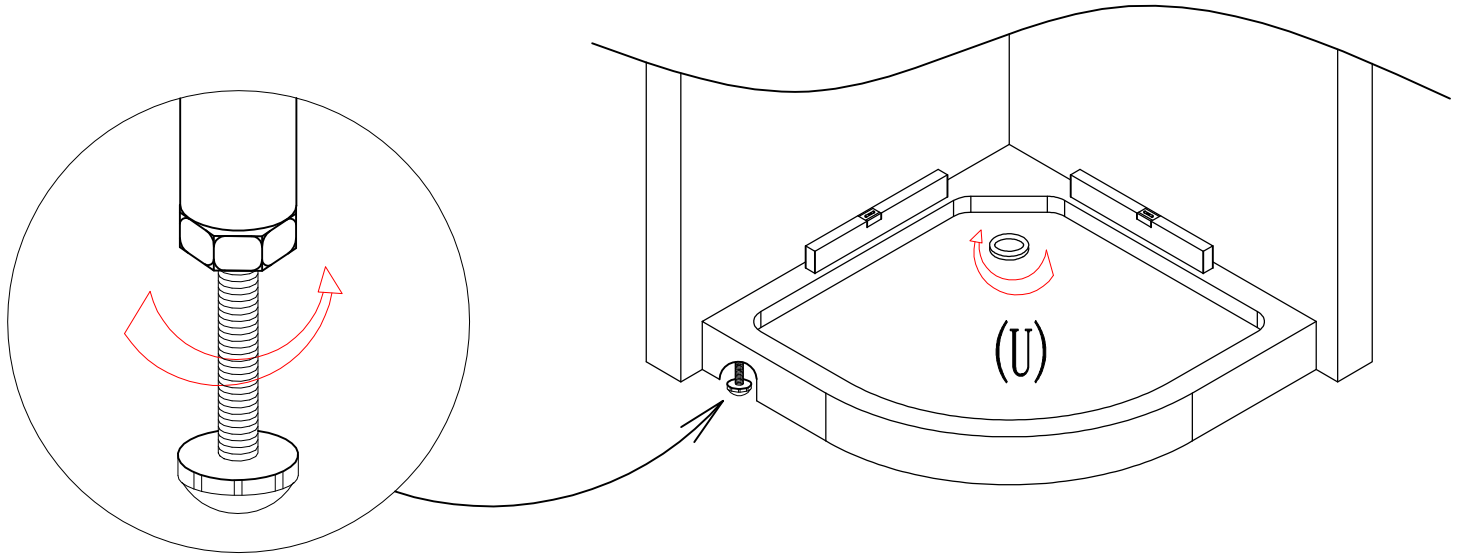
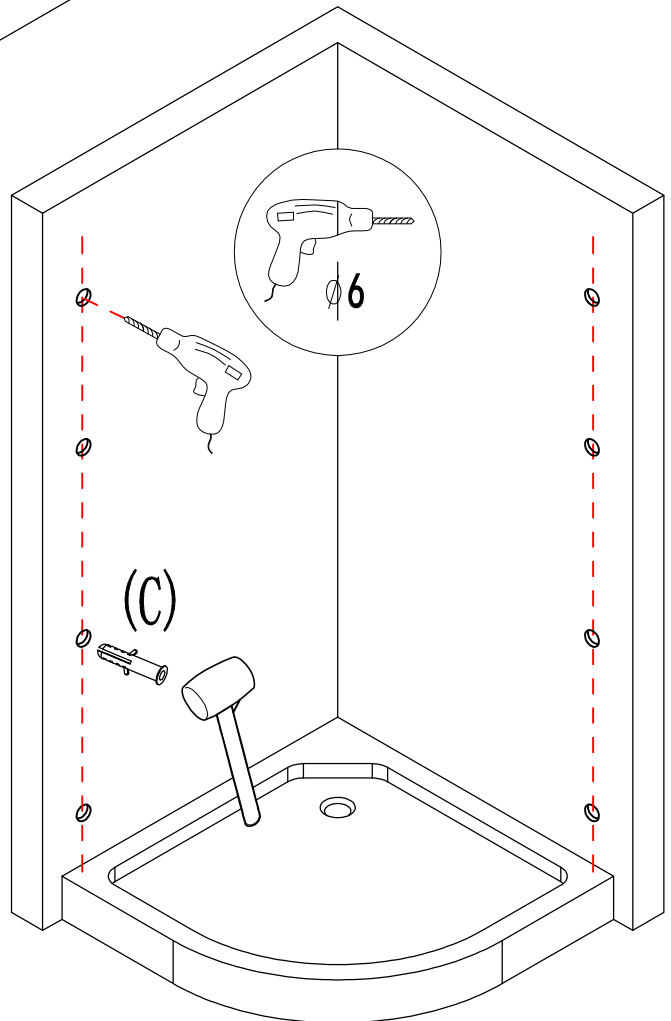
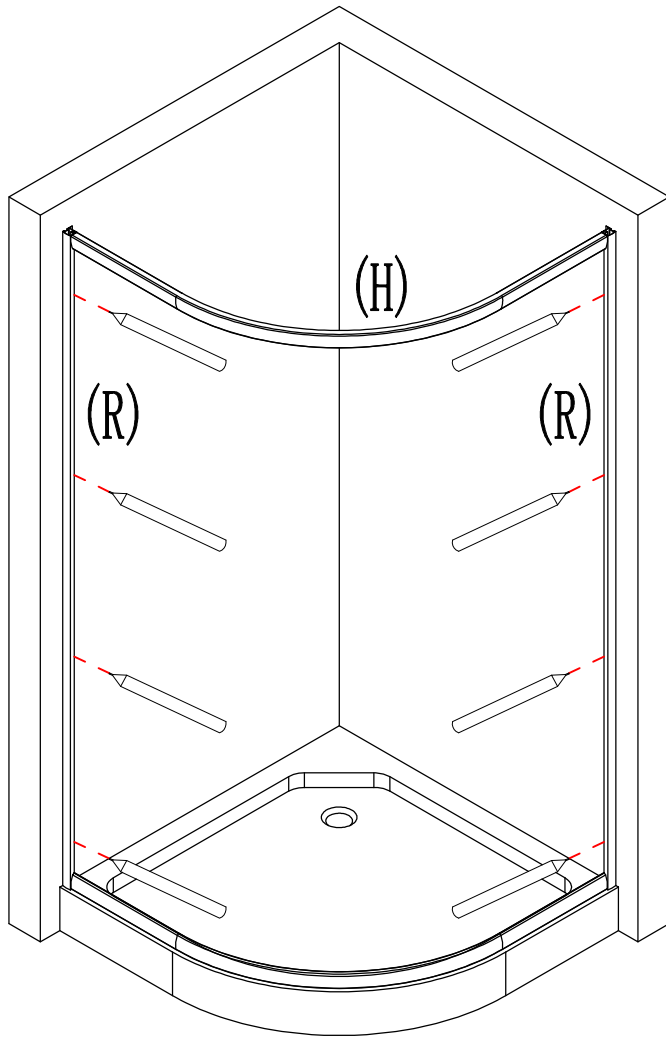

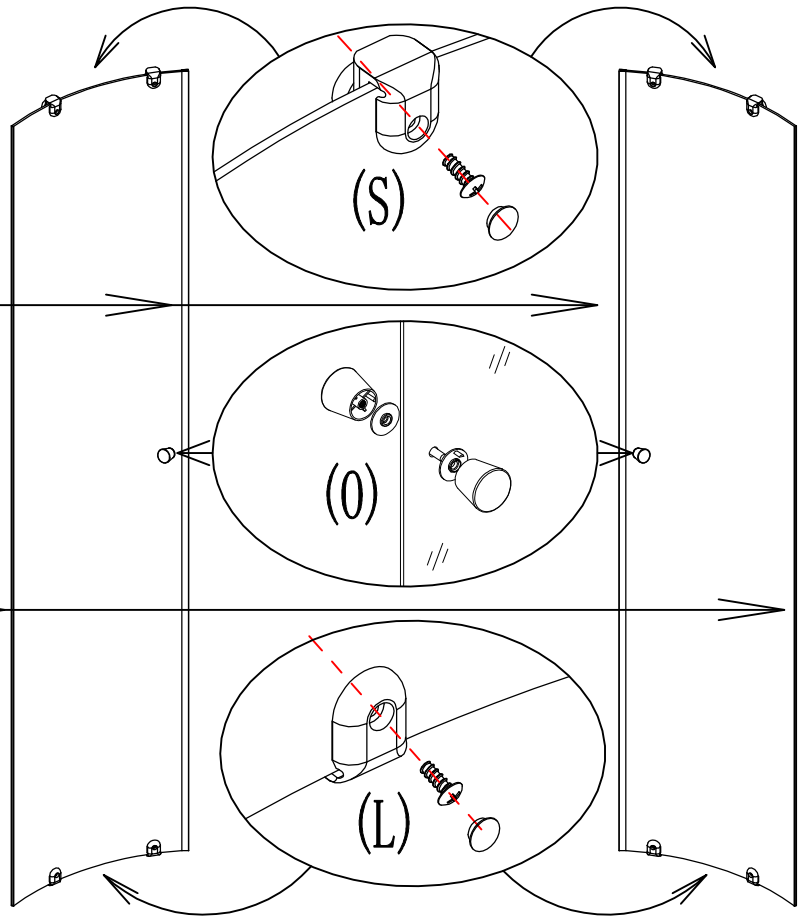
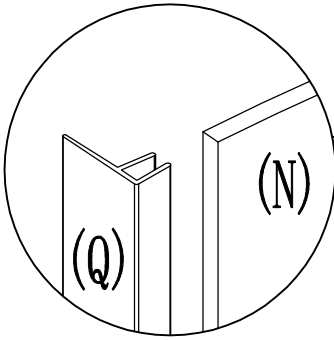
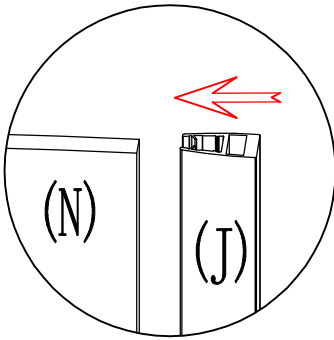
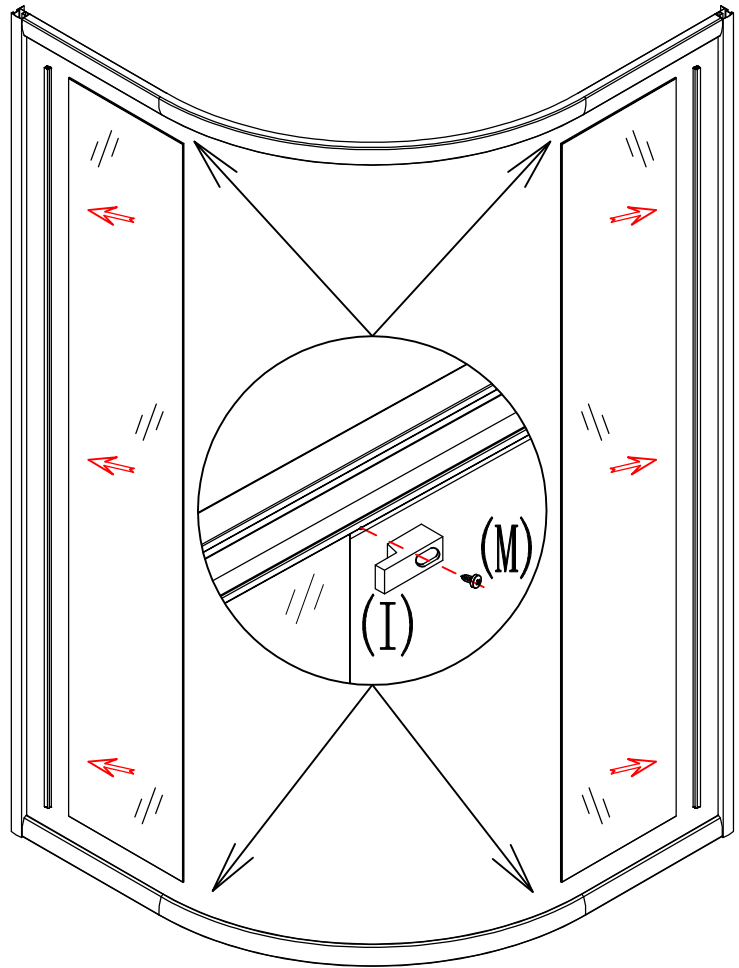
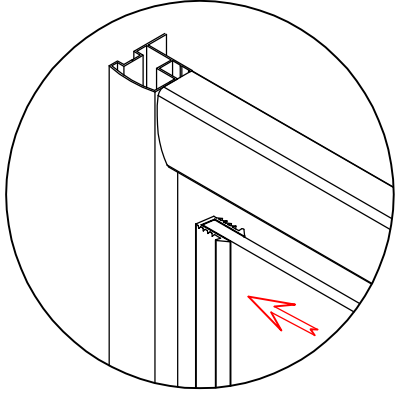
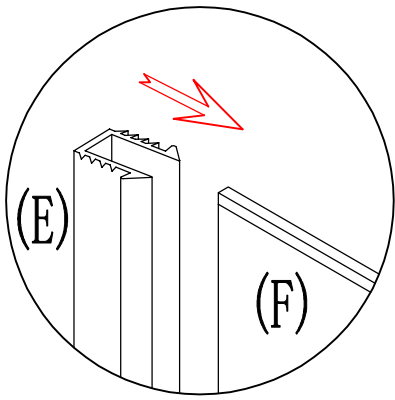

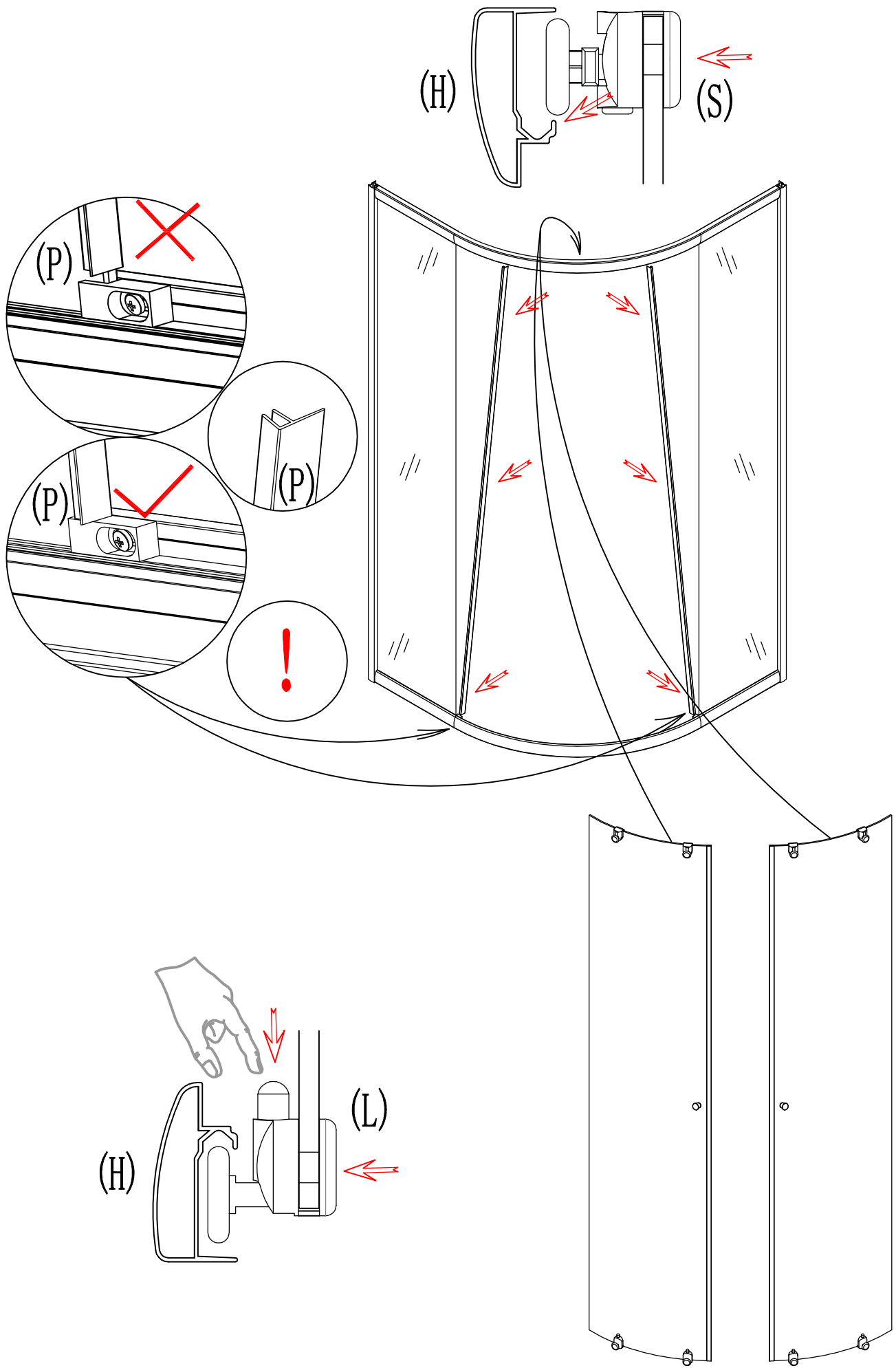

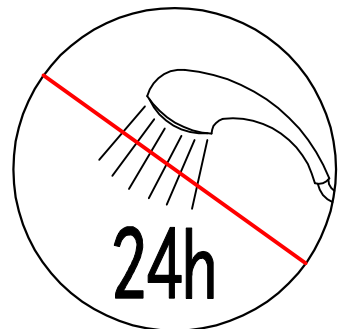
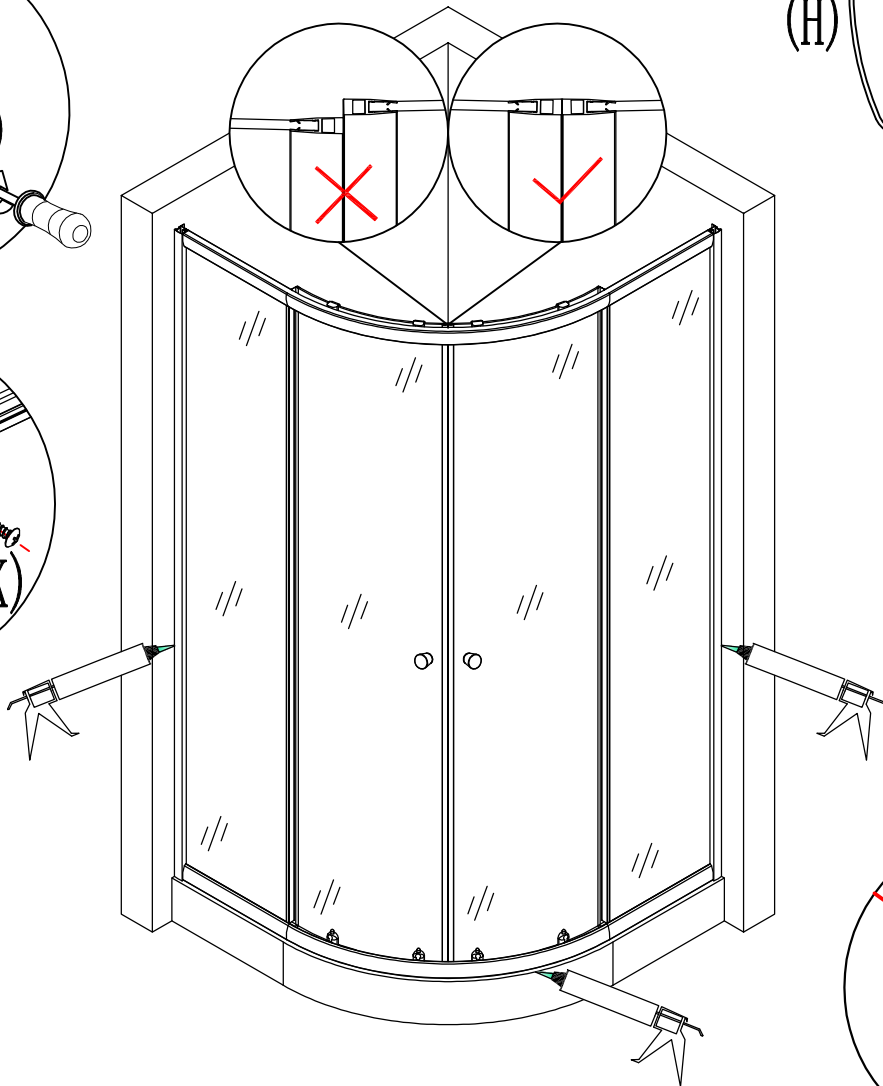
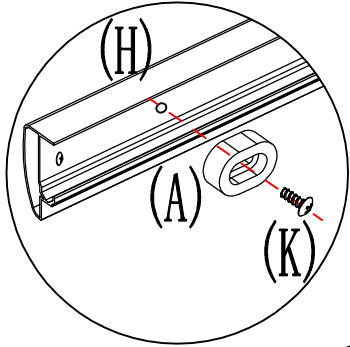
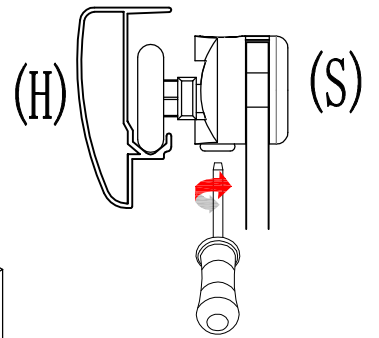
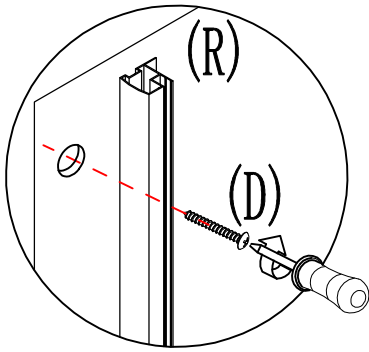
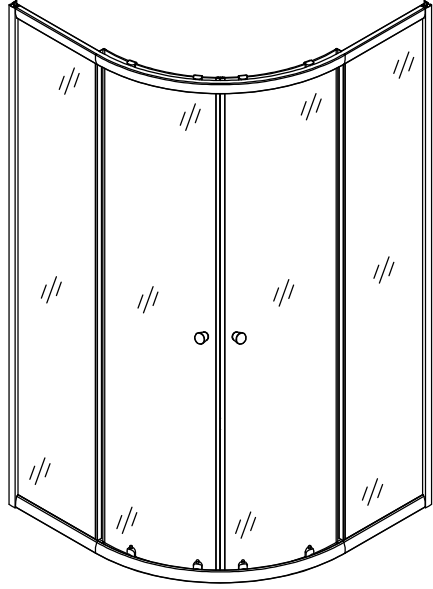
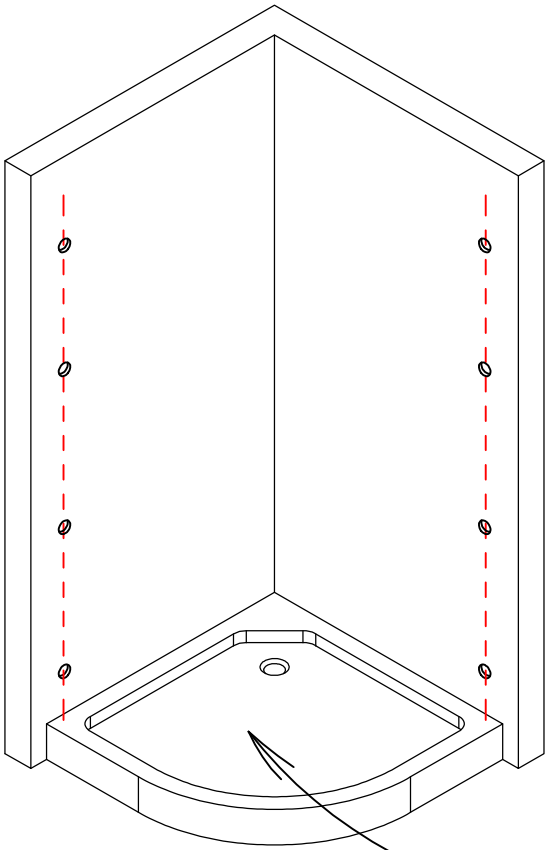

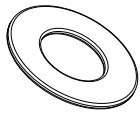

M12=6

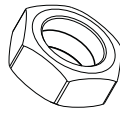

M12=23

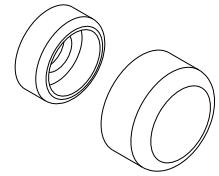

=3

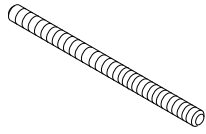

M12 X 10CM=1

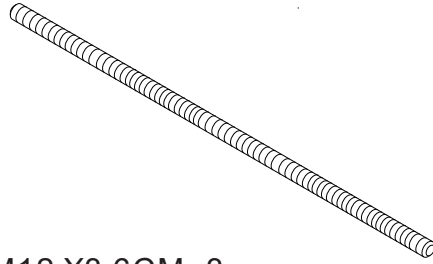

M12 X3 6CM=3

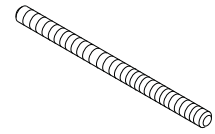

M12 X 18CM=1

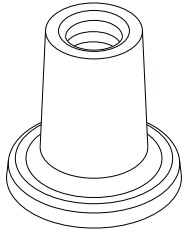

=5

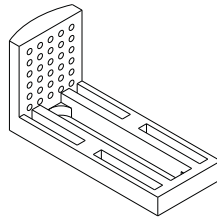

=3

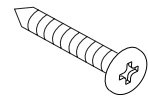

M4 X 20=3

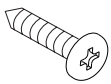

M4 X 12=4

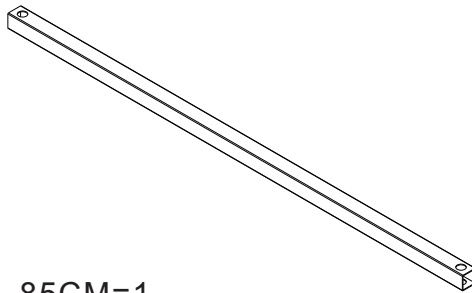

85CM=1

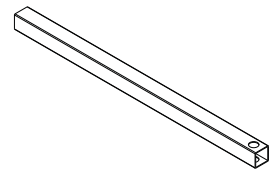

45CM=2

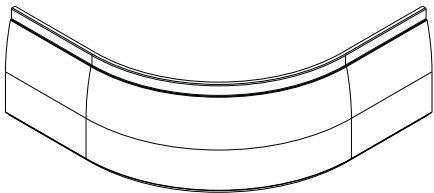

=1

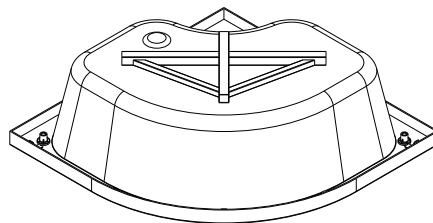

=1

